

# Review

## Multiple choice question

Sheet to be completed - 1

Leçon: 2.4.2

QUESTION:

Select the action that allows air to move into a diaphragm chamber and compress the parking brake spring.

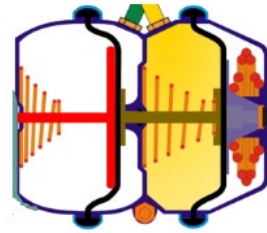

ANSWER CHOICE: Only one possible answer **X**  
Several possible answers

A) By pulling this command



B) By pressing the brake pedal



C) By pressing this command



**X**

D) None of the above

Refer to if wrong answer: **Lesson 2.4.2** from the student's workbook.

## Multiple choice question

Sheet to complete - 2

Leçon: 2.4.2

QUESTION:

Which of the following statements apply to the illustration above?

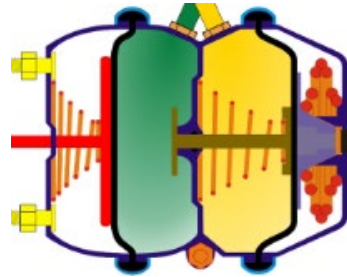

the

ANSWER CHOICE: Only one answer possible  
Several possible answers **X**

A) The service brake is applied

X

B) The parking brake is applied

C) The parking brake is released

X

D) The service brake is released

Refer to if wrong answer: **Lesson 2.4.2 from the student's workbook.**

## Multiple choice question

Sheet to be completed - 3

Leçon: 2.4.2

QUESTION:

**Which of the following statements apply to the illustration above?**

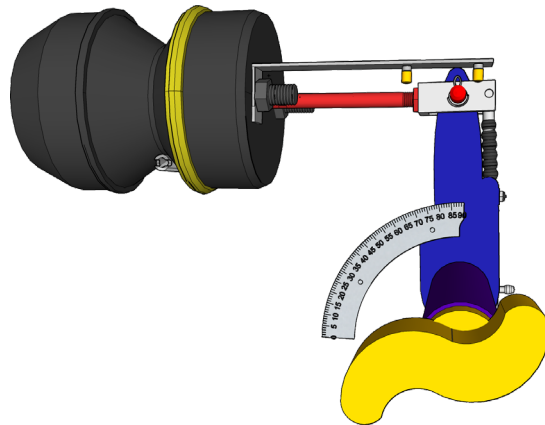

ANSWER CHOICE: Only one answer possible  
Several possible answers **X**

A) The brakes are applied, and the brake adjustment meets the standards.

**X**

B) The brakes are released.

C) The brakes are applied, and the brake adjustment do not meet the standards.

D) A 90-degree angle confirms that the brake is applied.

**X**

Refer to if wrong answer:

**The red indicator is between the two yellow indicators. The push rod and automatic adjuster form a 90-degree angle. Lesson 2.4.2 from the student's workbook.**

## Multiple choice question

Sheet to be completed - 4

Leçon: 2.4.2

QUESTION:

Which of the following statements applies to the illustration above?



ANSWER CHOICE: Only one possible answer **X**  
Several possible answers

A) 30 PSI (psi) is applied to the service brake.

**X**

B) 30 PSI (psi) is the volume of air available in the supply tank.

C) 30 PSI (psi) is the volume of air present in the air suspension.

D) None of the above

Refer to if wrong answer:

**Application pressure gauge. Lesson 2.4.2 from the student's workbook.**

## True or False

Sheet to complete - 5

Leçon: 2.4.2

QUESTION:

**Emergency brakes will apply when the air pressure (PSI) in the pneumatic system is no longer sufficient to compress the parking brake spring.**

ANSWER CHOICES:

TRUE

X

FALSE

Feedback if wrong answer: **Lesson 2.4.2 from the student's workbook.**

- True or False

Sheet to be completed - 6

Leçon: 2.4.2

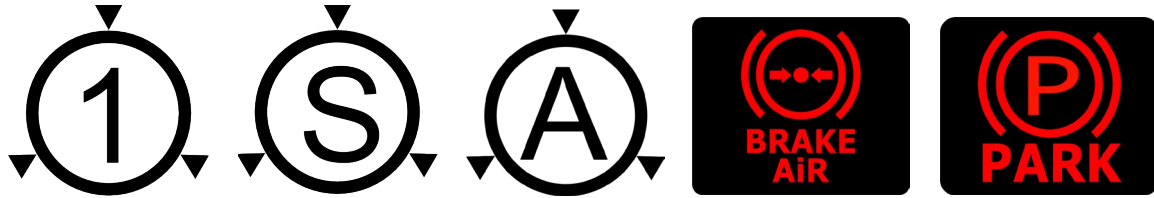

QUESTION:

The following pictograms and warning lights are all connected to the air brake system.

ANSWER CHOICES:

TRUE

X

FALSE

Refer to if wrong answer: **Lesson 2.4.2 from the student's workbook.**

QUESTION 7:

A



B



C



Associate illustrations A, B and C above with the following images of dual brake actuators:

Corresponding letter:

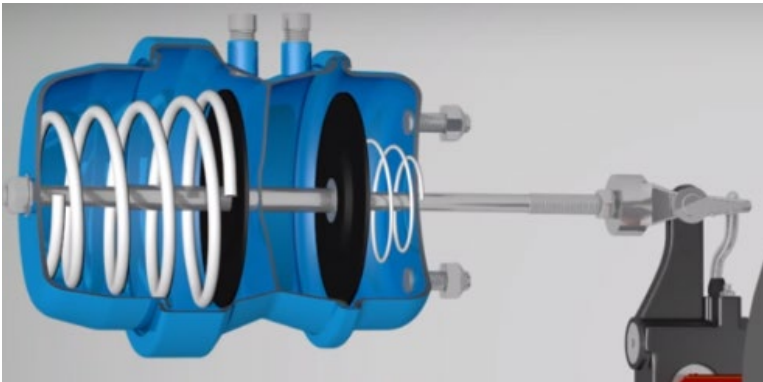

C

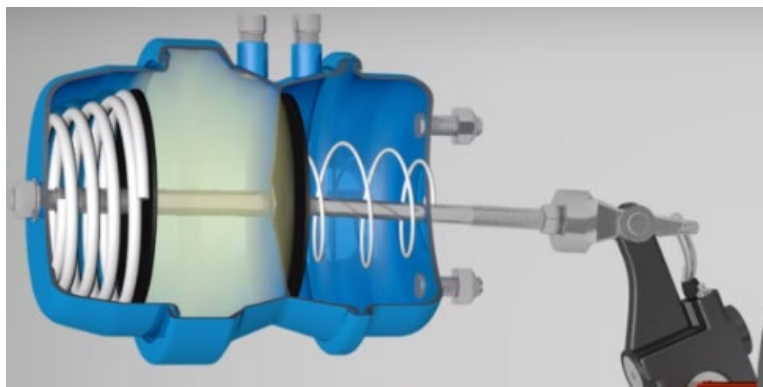

A

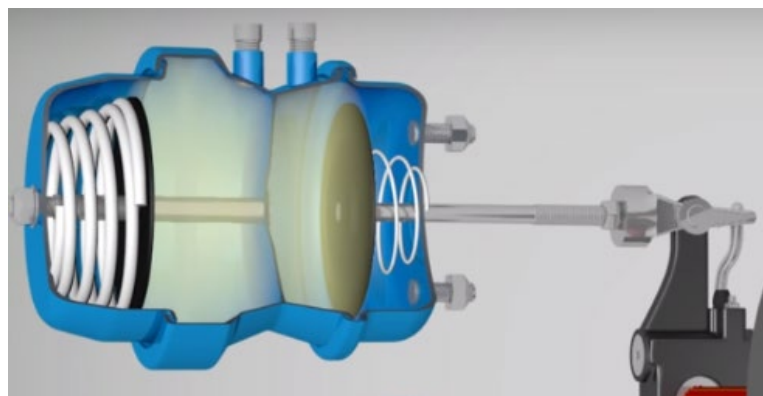

A et B